

Land Information Memorandum

L210616

Application

102633-287
Parry Fields Lawyers
PO Box 8020
Riccarton
Christchurch 8440

No.	L210616
Application date	15/03/21
Issue date	19/03/21
Phone	03 348 8480
Fax	-

Property

Valuation No.	2405533900
Location	479 East Maddisons Road
Legal Description	LOT 1 DP 74660 BLK III LEESTON SD
Owner	Hughes Developments Limited
Area (hectares)	5.4920

The certificate of title submitted with this application, shows easements, covenants, encumbrances or caveats registered on the title, for further information a copy of these can be obtained from Land Information New Zealand 112 Tuam Street.

Rates

Rateable Value

The date of Selwyn's last General Revaluation was 1/07/18. For further information please contact Council's Rates Department.

Revaluation Year	2018
Land	\$560,000
Capital Value	\$890,000
Improvements	\$330,000

Current Rates Year 2020 to 2021

Annual Rates	\$2,738.10
Current Instalment	\$ 684.55
Current Year - Outstanding Rates	\$ 0.00
Arrears for Previous Years	\$ 0.00
Next Instalment Due	15/06/21

Next Revaluation Due 2021.

The rates listed for this property are correct as at the date of this report being issued.

If this property is vacant land, and the applicant intends building a house or making other improvements, additional rates and charges will be added. Such rates and charges are for the operation of the District

libraries, local community centre and recreation reserves, sewerage and water systems and refuse collections and recycling.

If a ratepayer in the district purchases additional properties, that ratepayer maybe eligible for certain rating exemptions due to multiple ownership. The exemptions would only apply to uniform library charges on bare land blocks and an exemption from the uniform annual general charge if contiguous or same use land is purchased.

Please contact the Councils rates team if you require clarification (03) 347 2800.

Note: Rates are charged in four equal instalments for the period commencing 1 July and ending 30 June each year.

Planning/Resource Management

Operative District Plan Zoning: Rural Inner Plains

The Council has undertaken a review of the Operative District Plan and through this process it has developed a Proposed District Plan which provides clear objectives, policies and rules to manage the effects of land use activities on the environment, but also sets a clear direction for our district's development and reflects our communities' needs and expectations. It also incorporates any changes in legislation, national and regional policy statements, environmental standards and other regulations.

As a result, some of the Proposed rules apply from the date of notification – 5 October 2020. These are generally rules that relate to the things we look after, like listed historic notable trees, Sites and Areas of Significance to Māori, indigenous biodiversity and provisions associated with protecting the natural character of surface water bodies. In some cases, resource consent may be required under either or both the operative and proposed district plans.

Your current property zoning may also change as a result of the District Plan Review and the bulk and location requirements for your zone may also change, therefore we recommend you read the Proposed District Plan in full to see what the potential impacts may be.

The Proposed District Plan can be viewed in ePlan format at:

www.selwyn.govt.nz/proposedplan

Alternatively a summary guide which outlines the key changes between the Proposed and Operative plans and more information about the District Plan Review process can be found at:

www.selwyn.govt.nz/districtplanreview

Please note this information is subject to change following the close of submissions and decisions/appeals

5/09/96 Resource Consent R302376
Subdivision Of 21.16 Ha Into 3 Lots-5.4 Ha With Existing Dwg -10 Ha Bare Land Lot & 5.1 Ha
To Be Amalgamated Completion Certificate 19/02/97
Consent Approved 29/11/96

Planning Note

Please note: The information provided on this LIM has come from the information lodged against the property file/information and GIS at the time of processing. Please note that the resource consents listed are based on what is available on our general property information, and there may be other resource consents for the property which have not been added to the property record.

This property is subject to Plan Change 64. A decision has not yet been made.

Reference Plains Flood Management Overlay and Liquefaction Damage Unlikely Overlay

The District Plan Review has considered the potential effects of Natural Hazards such as flooding, tsunami, wildfire and geotechnical hazards such as land instability, liquefaction and fault lines on properties across the District. This property is identified by the Proposed District Plan as being located within a Natural Hazard Overlay.

For further information visit <https://yoursay.selwyn.govt.nz/selwyndistrictplanreview> or contact the Planning Department

Building

17/08/17	Building Consent 171412 Solid Fuel Heater Code Compliance Certificate Issued 15/09/17
24/05/10	Building Consent 100282 Domestic Dwelling Alterations & Additions - Change Of Use Code Compliance Certificate Issued 4/12/12
23/01/09	Pim Application 090007p Domestic Dwelling Alterations & Additions - Change Of Use Pim Only
20/05/92	Building Permit K38005 Implement Shed
5/10/89	Building Permit G002226 Dwelling
29/09/89	Building Permit 3721 D / 3722 P Drainage And Plumbing

No Code Compliance Certificate is required for a Building Permit. For those Building Consents with numbers that follow on from R410707 a Code Compliance Certificate is required. Consent R410707 is the first Building Consent issued by this Council which was not necessarily for this property.

Buildings erected prior to 1965 may not have a building permit record or had inspections carried out.

All building products and materials have a designed life, and must be maintained in accordance with the manufacturer's specifications.

In the case of building permits and building consents no further inspections have been carried out by the council since these structures were completed.

Any concerns of this nature should be referred to an organization that carries out property checks or the product manufacturers.

Services

Water Council water supply not available
Own potable water supply required

For those properties not connected to a Council reticulated water supply, it is encouraged that the quality of the domestic water supply be regularly tested to ensure that it is to a potable standard. If the same water supply is also used for irrigation or stock water, check that there is a backflow protection device to prevent any contamination of water supply.

Sewer Council sewer scheme not available
On-site sewage treatment and disposal

There is an existing domestic onsite wastewater treatment system on this property. The owner is responsible for ensuring regular maintenance and servicing is carried to ensure it continues to function satisfactorily.

Any new or replacement domestic onsite wastewater treatment system will need to meet the requirements of Rule 5.8 of the Canterbury Land and Water Regional Plan to be considered a permitted activity and will require a building consent from Selwyn District Council prior to installation.

Any property with onsite sewage treatment and disposal, animal effluent disposal or water extraction for irrigation may have or require consent from Environment Canterbury.

As this property may have or require consents from Environment Canterbury so to may the surrounding properties for a variety of discharges. This could have an adverse effect on this property in relation to odour, potable water supply quality, or be of a general nuisance factor.

Information regarding what consents have been granted for this or surrounding properties can be obtained by contacting the issuing authority Environment Canterbury – phone 3653828.

Land used to dispose of waste or to spread effluent or treated sewage, may be contaminated due to the concentrations or mix of material deposited onto the land over time. If any soil tests have been carried out, please forward a copy to the Council in order for the records to be updated.

For those properties not connected to a Council reticulated sewer system, it is important that the effluent system is regularly checked and maintained. You should also be aware of the limits on what can and should not be disposed of through these systems. Any concerns should be referred to an organization that carries out checks and maintenance or the product manufacturers.

Stormwater Disposal to be determine with new subdivision contact Asset Dept for more information

This property may be located within an area covered by Environment Canterbury stormwater consent. It is the responsibility of the property owner to contact Environment Canterbury customer services to ensure that any activity undertaken on site complies with the relevant consent conditions.

Note – the above describes the current roof water disposal type and does not reflect the future situation, which should be determined as part of the subdivision (if applicable). For more information please contact Council.

Kerbside Waste Collections Council refuse, organic and recycling collection available Friday

The Council provides refuse and recycling collection services for most residential and rural residential properties where these properties occur alongside maintained public roads. Private roads and Right of Ways (as maybe referenced in the Transportation Notes pertaining to this LIM) will not be directly serviced as these access ways are not usually of a sufficient standard to be used safely and efficiently by the collection vehicles. This could also apply to other public roads or streets that are narrow and/or have a lack of vehicle turning facilities. Rural and high country areas and settlements are not covered by regular collection services however localised refuse drop off facilities maybe available for use in specific areas. For further details and advice on refuse collection and recycling services as they may pertain to the property please phone the Council's Asset department on phone 3472 800.

Copy of drainage plan attached.

Water Race

An open or piped stockwater race may run through or adjacent to this property. Irrespective of whether the race is used, properties are rated for stockwater as outlined in Council's Policy W109. Property owners have responsibilities for; maintenance, providing access and fencing stock. A building setback applies to all races. Council approval is required for planting of the water races and installation of any structure in the race including culverts.

Potential Water Race Closures

Council has indicated in its Long Term Plan 2015-2025 that it will:

Proactively progress the closure of the Haldon water race intake (within the Ellesmere Water Race Scheme) including the down gradient race network which is supplied by this intake. Targeted Stream Augmentation will possibly be taken into account with some lengths of races remaining open to convey this flow.

Progress ratepayer initiated water race closures once approved by the Water Race Committee for closure.

Work with Central Plains Water to develop a concept for converting the Kowai River sourced water race network (part of the Malvern Water Race Scheme) into a combined water race and irrigation network. This concept will then be used for further consultation with the community.

Work with Environment Canterbury and key stakeholders to realise opportunities to use consented stock water for environmental enhancement including targeted stream augmentation.

Investigate options for integration of the stock water races with Central Plains Water.

The above intention may have a future impact on any water races that serve this property. Affected land owners will be consulted prior to any water race closures.

For further information on water races, please contact Selwyn District Council's Asset Department on phone 03 347 2800.

Land and Building Classifications

Archaeological Sites: None known

Historical Places: None known

Historical Trees: None known

Land Notes: This property is within the area encompassed by the 2007 Christchurch, Rolleston and Environs Transportation Study (CRETS). The published Strategy outlines a range of strategic transportation initiatives to cater for long term growth in this area of the District. This includes the upgrading of existing roads and the provision of new roads which may affect private property. Further information on this Study can be viewed on the Councils website www.selwyn.govt.nz under "Transportation and Roding".

Land Notes: The flight paths for the Christchurch International Airport takes air traffic over this general area

Land Notes: This property is located within the area encompassed by the Greater Christchurch Urban Development Strategy (UDS). The UDS is a joint initiative to plan and manage the growth of the Greater Christchurch Region over the next 35 years and is a partnership between the Christchurch City Council, Environment Canterbury, the Waimakariri District Council, Selwyn District Council, and the New Zealand Transport Agency.

The Selwyn District Council is developing a number of strategic documents that seek to implement the UDS that may have an impact on this property in the future. Further information on Council projects can be found on the Council's website www.selwyn.govt.nz or by contacting the planning department on (03) 347 2868.

Land Notes: This property may be listed on Environment Canterbury's Listed Land Use Register (LLUR). For further information, please contact Environment Canterbury directly – Phone 0800 324 636

Residential Swimming Pool

No pool registered to this property.

Land Transport Requirements

The section of East Maddisons and Selwyn Roads that pass this property are formed and sealed local roads maintained by the Selwyn District Council

Local Roads: Roads and streets servicing residential and rural development whose primary function is property access.

Special Land Features

	NZS3604:2011	AS/NZS1170:2002
Wind Region	A	A7
Snow Zone	N4	N4 SUB-ALPINE
Earthquake	Zone: 2	Z Factor: 0.3
Approximate Altitude (Amsl)	30 M	30 M
Exposure Zone	B	

Exposure Zone Descriptions

Zone B: Low

Inland areas with little risk from wind blown sea-spray salt deposits

Zone C: Medium

Inland coastal areas with medium risk from wind blown sea-spray salt deposits. This zone covers mainly coastal areas relatively low salinity. The extent of the affected area varies significantly with factors such as winds, topography and vegetation.

Zone D: High

Coastal areas with high risk wind blown sea-spray salt deposits. This is defined as within 500 m of the sea including harbours, or 100 m from tidal estuaries and sheltered inlets.

Microclimatic Considerations

In addition to exposure zones, evidence of local environmental effects (microclimates), and those produced by the erection of a structure or installation of equipment, shall be considered. Such on-site factors require additional consideration because a mildly corrosive atmosphere can be converted into an aggressive environment by microclimatic effects. Indications of such local conditions may be in the form of corrosion of metal items on adjacent structure. Significant acceleration of the corrosion rate of structural fasteners and fixings beyond what could be expected from geographical location can occur in the following circumstances:

- (A). Industrial contamination and corrosive atmosphere;
- (B). Contamination from agricultural chemicals or fertilizers; and
- (C). Geothermal hot spots. Hot spots are defined as being within 50 m of a bore, mud pool, steam vent, or other source.

Microclimatic conditions (a) to (c) require Specific Engineering Design.

Flooding: Flood Management Area - 500 year event

The Council is undertaking a District Plan Review and through this process the Council has obtained and holds information showing that this property may be susceptible to flooding from the Selwyn River and/or in heavy rainfall events. The two reports are outlined below and can be found at <https://apps.canterburymaps.govt.nz/SelwynNaturalHazards/>:

ECan report R19/41 – Selwyn River/Waikirikiri floodplain investigation. The report identifies areas that may be affected by flooding from the Selwyn River/Waikirikiri.

DHI Water and Environment Ltd report – Regional Policy Statement Modelling for SDC – District Plan. The report identifies areas that may be affected by flooding in heavy rainfall events in the Selwyn District.

For more information please contact the Selwyn District Council: phone: 0800 SELWYN (735 996), email contactus@selwyn.govt.nz or visit 2 Norman Kirk Drive, Rolleston.

Alluvion: None known

Avulsion: None known

Erosion: None known

Land Fill: None known

Hazardous Contamination: None known

Slippage: None known

Ground Water Level: Less than 30 metres below ground

Soil Type: Lismore stony and shallow silt loam

Liquefaction and Subsidence: Council does not hold site specific information on subsoil classifications or ground bearing capacities. Therefore the applicant will need to carry out site subsoil investigations to verify 'Good Ground' can be achieved on the site and to determine the subsoil classification in accordance with NZS1170. Verification of site investigation data will need to be submitted as part of the documentation for Building Consent.

The definition of 'Good Ground' can be found in the Definitions section of the NZ Building Code Handbook, and appropriate test methods are detailed in either NZS3604, or NZBC B1/VM4.

Licences/Environmental Health

No information located.

Network Utility Operators

Information related to the availability of supply, authorisations etc. (e.g. electricity or gas) can be obtained from the relevant Network Utility Operator.

Other Information

1. The applicant is advised that the Environment Canterbury may have other information in relation to this property including, but not limited to:

- a) Discharge consents.
- b) Well permits.
- c) Consents to take water.
- d) The existence of contamination and/or hazardous sites.
- e) Flooding.
- f) Clean air discharge compliance.

Further information may be obtained from Environment Canterbury by requesting a Land Information Request (LIR). To find out more contact the Environment Canterbury on 0800 ECINFO (0800 324 636) or at <http://www.ecan.govt.nz/>

2. The following further information is supplied on the basis set out in note 2 below.

Notes

1. The information supplied in the sections of this report, other than 'Other Information', is made available to the applicant pursuant to Section 44A(2) of the Local Government and Official Information Act 1987 by reference to Council files and records. No property inspection, or title search, has been undertaken. To enable the Council to measure the accuracy of this LIM document based on our current records we would appreciate your response should you find any information contained herein which may be considered to be incorrect or omitted. Please telephone the Council on (03) 3472800.
2. The information or documents supplied to the applicant and referred to in the 'Other Information' section of this report has been supplied to the Council by property owners, their agents and other third parties. That information is made available pursuant to section 44A(3) of the Local Government and Official Information Act 1987 on the basis that:
 - a) The information may be relevant to the purposes for which this report is obtained;
 - b) The Council does not warrant or represent the accuracy or reliability of the information. If the subject matter of that information is important to the applicant it is recommended that relevant professional advice should be taken before reliance is placed upon that information.
3. The information included in the LIM is based on a search of Council records only and there may be other information relating to the land which is unknown to the Council. Council records may not show illegal or unauthorised building or works on the property. The applicant is solely responsible for ensuring that the land is suitable for a particular purpose.

4. Perspective purchasers should be aware that the Building Act 2004, contains a list of building work in Schedule 1 (Building work for which building consent not required). The list of work in Schedule 1 has been regularly reviewed and amended over the years with more types of building work added on several occasions, for example amendments which became effective in November 2013, means that council may not have records for the removal or demolition of buildings on this property. It is important that perspective purchaser's understand that it is the owners responsibility to ensure that any exempt building work done complies with the Building Code and fits within the provisions of the schedule before they carry out the work. It is also important to check when the work was actually done, as the amendments to the schedule cannot be applied retrospectively to work.

Perspective purchasers are advised as part of their due diligence process to verify that all buildings that exist on the site have been issued with a building consent/permit or seek details from the current owner to satisfy themselves if the building work was carried out and complied with the Schedule 1 provisions.

Further information on Building work that does not require a building consent go to <https://www.building.govt.nz/projects-and-consents/planning-a-successful-build/scope-and-design/check-if-you-need-consents/building-work-that-doesnt-need-a-building-consent/>

Noting this is the latest amendment which came into effect on the 30 October 2020, previous versions of schedule can be viewed under versions and amendments to the Building Act 2004 at <http://www.legislation.govt.nz/act/public/2004/0072/latest/versions.aspx>

5. The Council has used its best endeavors to ensure that all information provided in this LIM report is correct and complete in all material respects. In the event that a material error or omission can be proven the Council's liability, whether in contract or in tort shall be limited to the fee paid to Council to obtain this report.
6. This information reflects the Selwyn District Council's current understanding of the site, which is based only on the information thus far provided to it and held on record concerning the site. It is released only as a copy of those records and is not intended to provide a full, complete or totally accurate assessment of the site. As a result the Council is not in a position to warrant that the information is complete or without error and accepts no liability for any inaccuracy in, or omission from, this information.

7. The information contained in this Land Information Memorandum is current at the date the memorandum is issued. Further relevant information may come into the Council's possession subsequent to the date of issue.

Name: Chaya Stevens



Date: 19 March 2021

Legend

Railway

Railway

Road

Selwyn Roads

All Road Labels

Rating

Ratepayer Information

Title Owners

Parcels

Water

Water_pt

EQUIPMENT

FACILITY

FIRE_PLANT

HYDRANT

IRRIGATION

NODE

OBSOLETE

SUPPLY_POINT

TANK

VALVE

Water_In

DIM LINE

DUCT

IRRIGATION

NON SDC SERVICE

OBSOLETE

OUTLINE

PIPE

SITE_BOUNDARY

Sewer

Manhole Labels

Sewer_pt

CHAMBER

EQUIPMENT

FACILITY

MANHOLE

NODE

VALVE

Sewer_In

OUTLINE

DIM LINE

DUCT

IRRIGATION

NON SDC SERVICE

OBSOLETE

OUTLINE

PIPE_GRAVITY

PIPE_RISINGMAIN

SITE_BOUNDARY

Sewer_py

Stormwater

Storm_pt

CHAMBER

EQUIPMENT

FACILITY

INLET/OUTLET

MANAGEMENT

MANHOLE

NODE

SOAKHOLE

SUMP

VALVE

Storm_In

CHANNEL

DIM LINE

MANAGEMENT

NON SDC SERVICE

OBSOLETE

OUTLINE

PIPE

SITE_BOUNDARY

Soakhole w/Hoz Soakage

StopBank

Storm_py

CATCHMENTS

CONSENT AREA

GROUNDWATER LESS 6M

OUTLINE OF BASIN

RATED AREA

Stormwater Management Area

Storm_In_Labels

WaterRaces

WRace_pt

DISCHARGE

DIVIDE

EQUIPMENT

GATE

GRILL

HEADWALL

MANHOLE

NODE

POND

SITE

SHAFT

SOAKHOLE

WRace_In

AQUEDUCT

CULVERT

DIM LINE

EMERGENCY DISCHARGE

INTAKE

LATERAL

LOCAL

MAIN

OBSOLETE

OUTLINE

SIPHON

TUNNEL

Drain

CDrain_pt

GATE

Site

WEIR

CDrain_In

DRAIN

ECan

OUTLINE

StopBank

Site Boundary

CDrain_In Label

LiquefactionReview

Project Extent

Boundary Between Liquefaction Assessment Zones

Liquefaction Susceptibility

DBH TC Zoned Area

Damaging liquefaction unlikely

Liquefaction assessment needed

Zones

Dairy Processing

DPMA

NCB

West Melton Observatory Zone

Planning Zones

High Country

Port Hills

Existing Development Area

Living 1

Living 2

Living 3

Living X

Living WM

Living Z

Deferred Living

Business 1

Business 2

Business 3

Inner Plains

Outer Plains

Malvern Hills

Key Activity Centre

Property Zone and Water Services Map

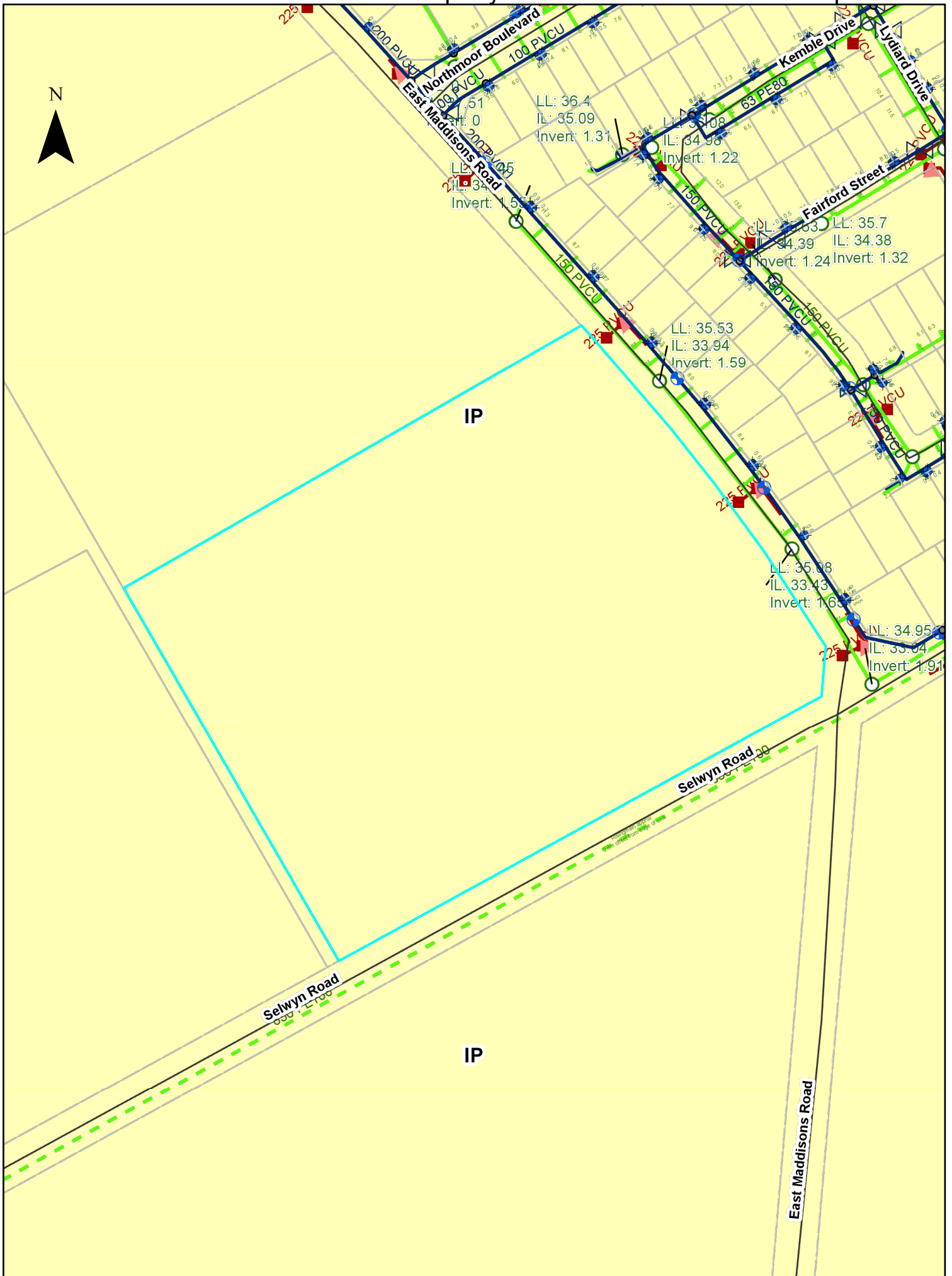

IP

IP

Selwyn Road

Selwyn Road

East Maddisons Road

Wate Race and Liquefaction Map

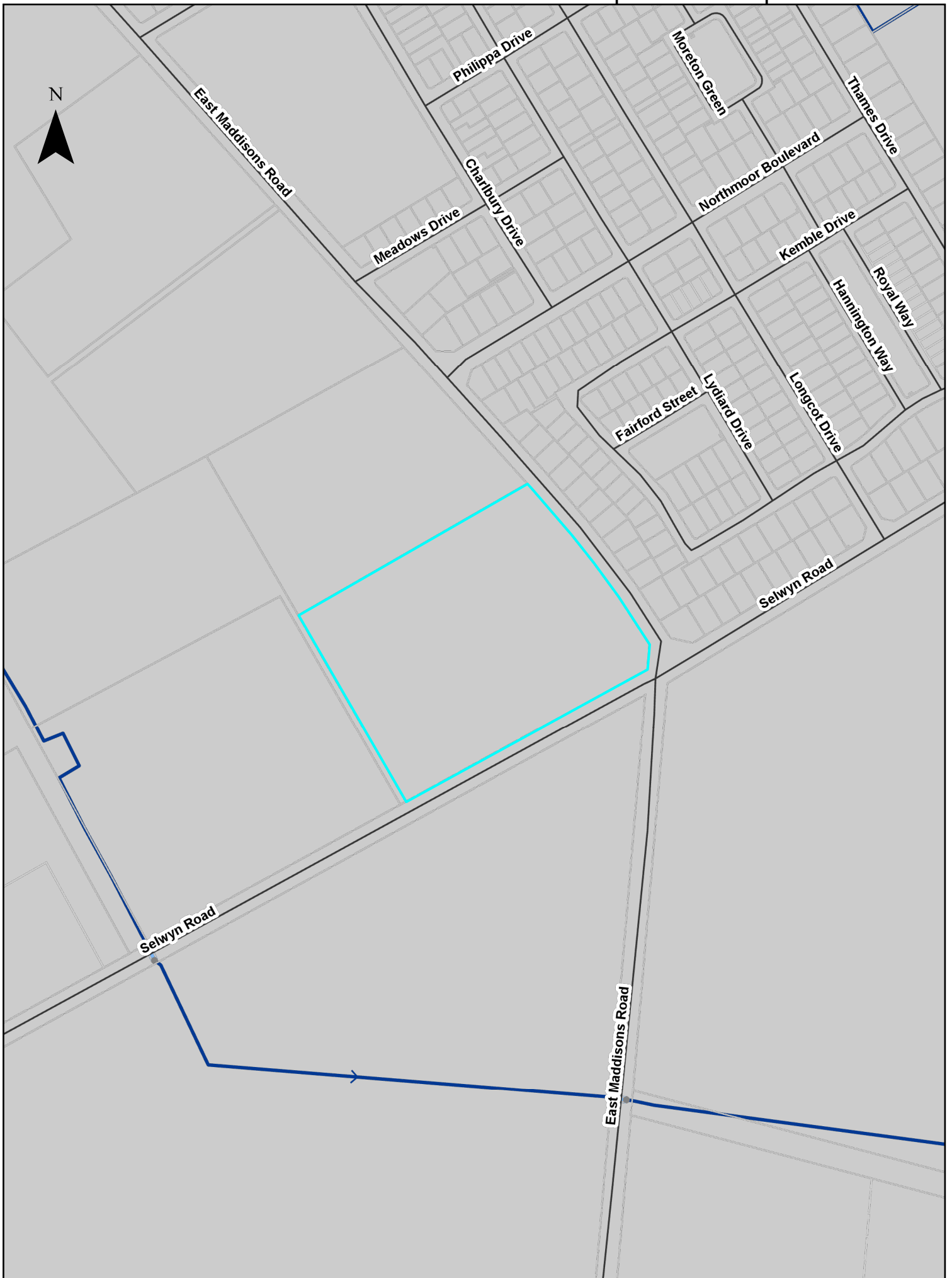

RESOURCE CONSENT INFORMATION

This document is one of three pages titled “Resource Consent Information” which should be read together.

- Because of the large number of resource consents only consents which fall within the red buffer as identified on the map have been included with this report.
- If further information is required please contact the Council’s Planning Department – Phone Direct 03 3472 868.
- Every effort is made by the Council to identify resource consent in proximity to the property subject to this LIM application. However, it is suggested that a site inspection be undertaken by prospective purchasers to identify any land uses of interest. These may include uses which have existing use rights or other uses which are permitted under the Council’s District Plan.

Resource Consent Status Codes:

GHP	Granted by Hearing
GEC	Granted by Environment Court
GDEL	Granted by Delegation
GCOM	Granted by Commissioner
DCOM	Declined by Commissioner
DHP	Declined by Hearing
WD	Withdrawn application
AP	Approved
DC	Declined
Blank	No decision issued

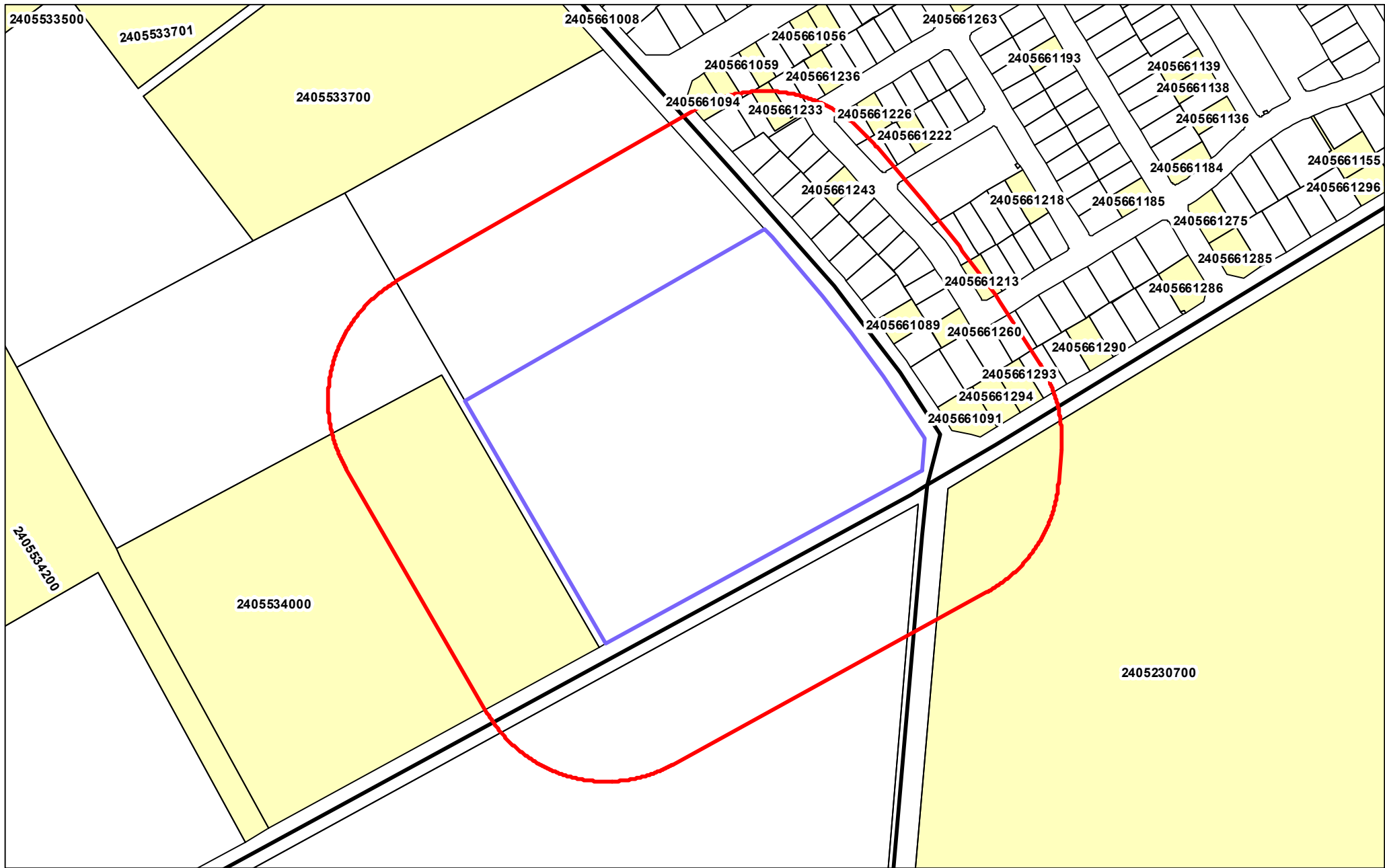

Cadastral Information derived from
Land Information New Zealand's Digital Cadastral Database (DCDB)
CROWN COPYRIGHT RESERVED
Approved for internal reproduction by Selwyn District Council
Digital Licence No. 133562-01

Resource Consent Map 100m Buffer



Assessment ID	Consent Number	Proposal	Status	Date
2405534000	R307112	TO RETAIN DWELLING ON LOT 1 & ERECT A DWELLING ON LOT 2	GDEL	2005-02-01
2405534000	R307111	TO CREATE 2 LOTS > 4 HA ZONED RURAL B / INNER PLAINS	GDEL	2005-02-01
2405661233	205011	VARIATION - To erect a dwelling with the garage forward of the front façade as a variation of Condition 2 of 165486.	GDEL	2020-02-10
2405661293	205241	VARIATION - To change condition 1 of resource consent RC185486.	GDEL	2020-05-25
2405661213	195645	To carry out a subdivision to create two residential lots and to cancel and add consent notice. L/U RC195646 & RC195647		
2405661213	195646	To erect a dwelling with decreased manoeuvring room (proposed Lots 544 & 545) S/D RC195645 & RC195647		
2405661213	195647	VARIATION - To change condition 3(d) of resource consent RC165486		
2405661213	195781	To undertake comprehensive subdivision and cancel consent notice.	GDEL	2020-05-12
2405661213	195782	To erect two dwellings and construct vehicle crossings.	GDEL	2020-05-12
2405661260	195311	To construct a vehicle crossing within 7m of a neighbouring right of way		
2405661294	195275	VARIATION - To change condition 1 of resource consent RC165486	GDEL	2019-06-24
2405661062	175406	Variation to change conditions of RC165482 to alter staging.	GDEL	2017-08-18
2405661089	185011	To change condition 1 of resource consent RC165486 exceeding site coverage	GDEL	2018-02-13
2405661089	175727	VARIATION - To erect a dwelling exceeding site coverage.		
2405661091	205264	VARIATION - To change condition 1 of resource consent RC165486.	GDEL	2020-06-11
2405661243	195123	To construct a dwelling and vehicle crossing where the vehicle crossing is located in a non-complying position in relation to an intersection	GDEL	2019-04-09
2405230700	105087	CHANGE OF CONDITIONS TO R307662 - TO RETAIN METAL SURFACE IN CARPARKING AREA	GDEL	2011-09-07
2405230700	R307662	TO ESTABLISH CARPARK ADJACENT TO SCHOOL ALSO SEE 105087 FOR VARIATION	GDEL	2005-11-17
2405661094	195228	To construct a vehicle crossing in a non-complying location in relation to an intersection	GDEL	2019-06-06

Code Compliance Certificate**100282****Section 95, Building Act 2004****The Owner**

Name of Owner:	Hood Christopher Ian & Mitchell Deanna Marie		
Mailing address:	479 East Maddisons Road, RD 8, Christchurch 7678		
Street address/registered office:			
Phone number:			
Landline:	Daytime:	3474282	
Mobile:	After hours:		
Facsimile number:	3474286		
Email address:	thehoods@clear.net.nz		
Website:			

The Building Work

Street Address of Building:	479 EAST MADDISONS ROAD, ROLLESTON		
Legal Description of land where building is located:	LOT 1 DP 74660 BLK III LEESTON SD		
Valuation Number:	2405533900		
Current lawfully established use:	DETACHED DWELLING		
Type of work:	DOMESTIC DWELLING ALTERATIONS & ADDITIONS - CHANGE OF USE		
Estimated Value:	\$95,000		
Location of building within site/block number:			
Building Name:	Year Construction Commenced:	2010	

Code Compliance Certificate:

The Building Consent Authority named above is satisfied on reasonable grounds,
that-
the Building work complies with the Building Consent

Chris Westwood
Selwyn District Council Building Consent Authority
Signatory

Issue Date: 4/12/12

Code Compliance Certificate

Section 95, Building Act 2004

The Building

Street address of building: 479 East Maddisons Road, Rolleston

Legal description of land where building is located: LOT 1 DP 74660

Building name: N/A

Location of building within site/block number: 479 East Maddisons Road
Rolleston

Level/unit number: N/A

Current, lawfully established, use: 2.0 Housing: 2.0.2 Detached Dwelling

Number of Occupants: N/A

Year first constructed: 2017

The Owner

Name of owner: C I Hood & D M Mitchell

Contact person: Chris Hood

Mailing address: 479 East Maddisons Road, RD 8, Christchurch

Street address/registered office: 479 East Maddisons Road, Rolleston

Phone number: 033474282

Mobile: 0272205459

Facsimile number: N/A

Email address: thehoods@clear.net.nz

First point of contact for communications with the council/building consent authority: Chris Hood

Building Work

Building consent number: BC171412

Description: Solid Fuel Heater

Issued by: Selwyn District Council

Code Compliance

The building consent authority named below is satisfied, on reasonable grounds, that -

- the building work complies with the building consent.

Matthew Talbot

Building Control Officer

On behalf of: Selwyn District Council

Issue Date: 15 Sep 2017



DRAINAGE PICKUP

CONSENT NUMBER

Address: 6/5/2011
Date: 4/7/12 Eastwoodlea S.R.D.

Drainlayer: Mickey Moore Drainage LTD
Dane Willis - 24133
Inspector:

100282

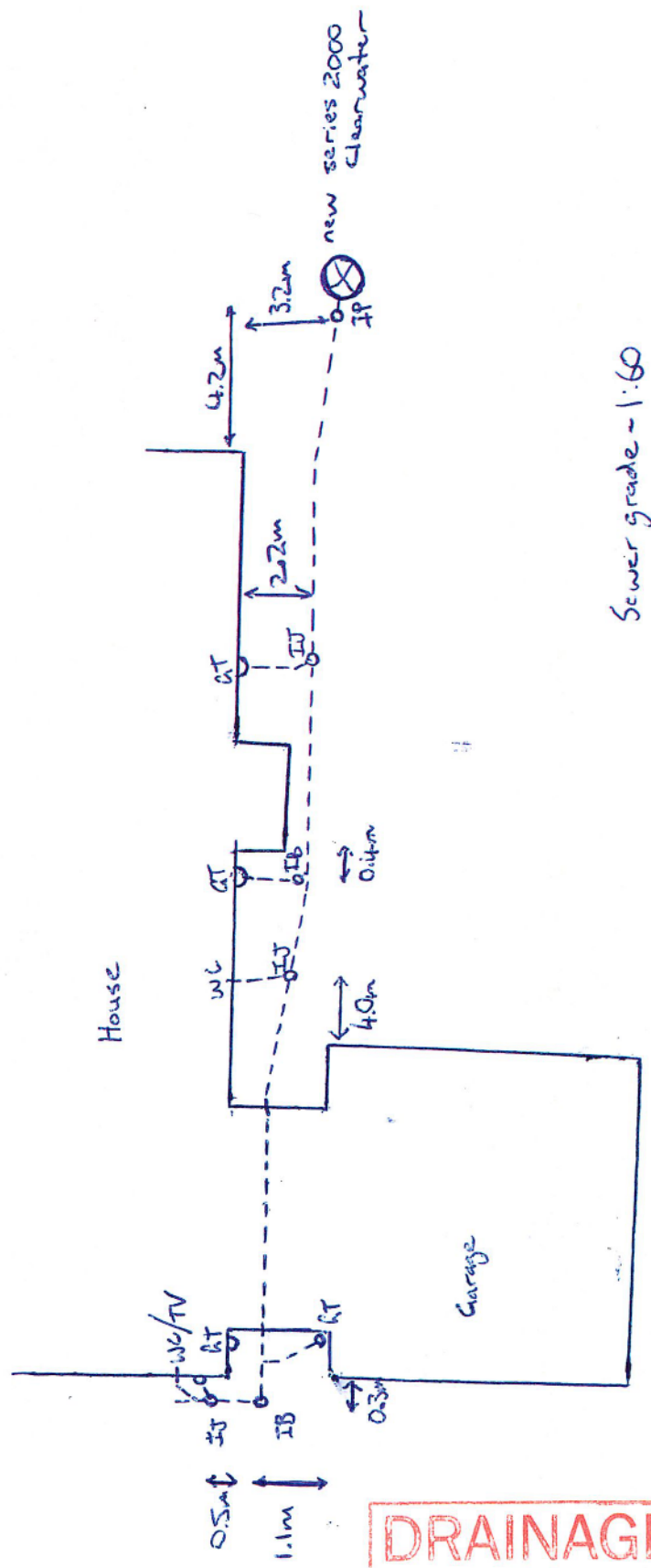

DRAINAGE PLAN

BC / PERMIT No: 100282

DATE: 9/12/12

Brent Miller
Reg # 19732

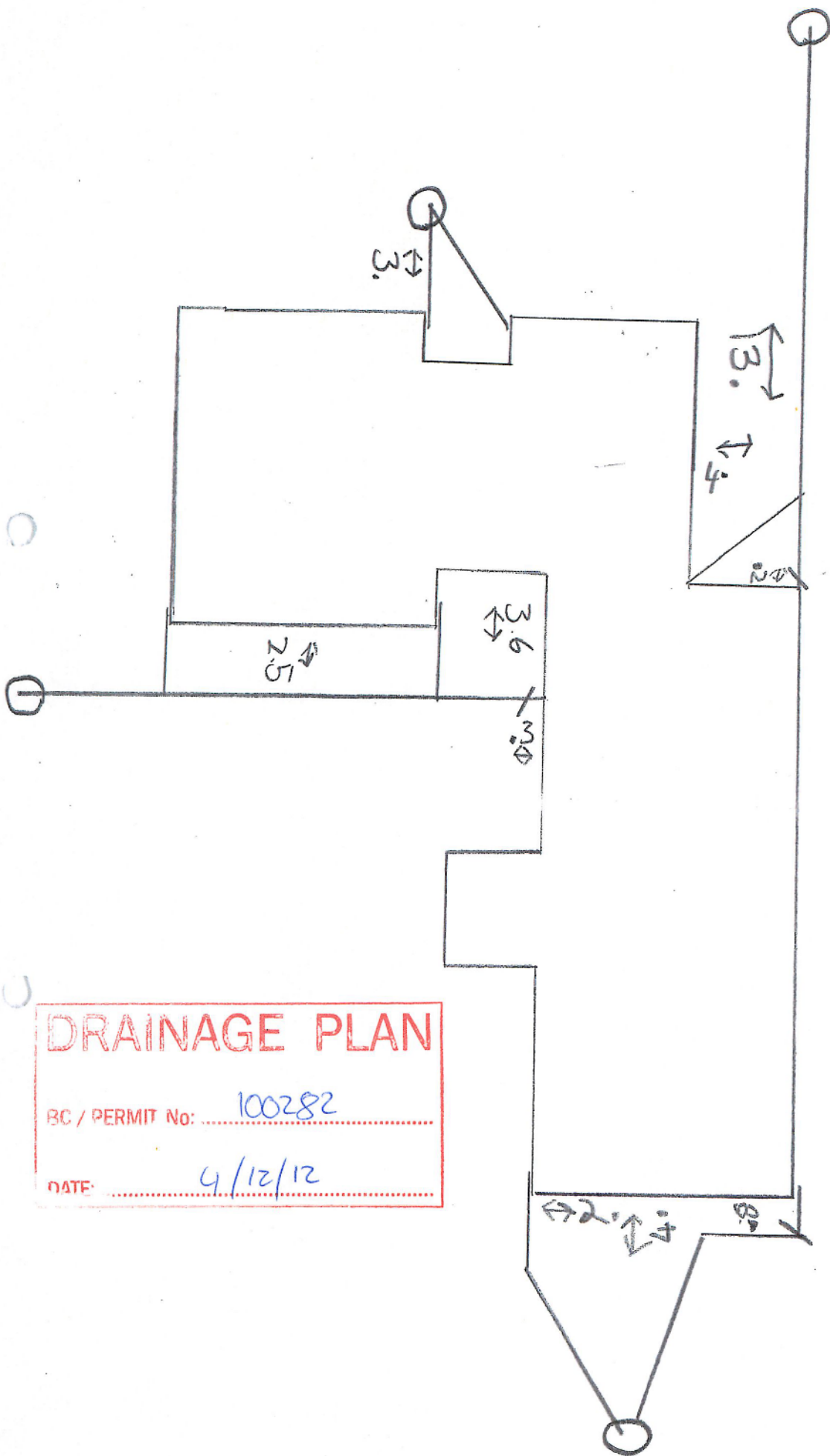

DRAINAGE PLAN

BC / PERMIT No: 100282

DATE: 4/12/12

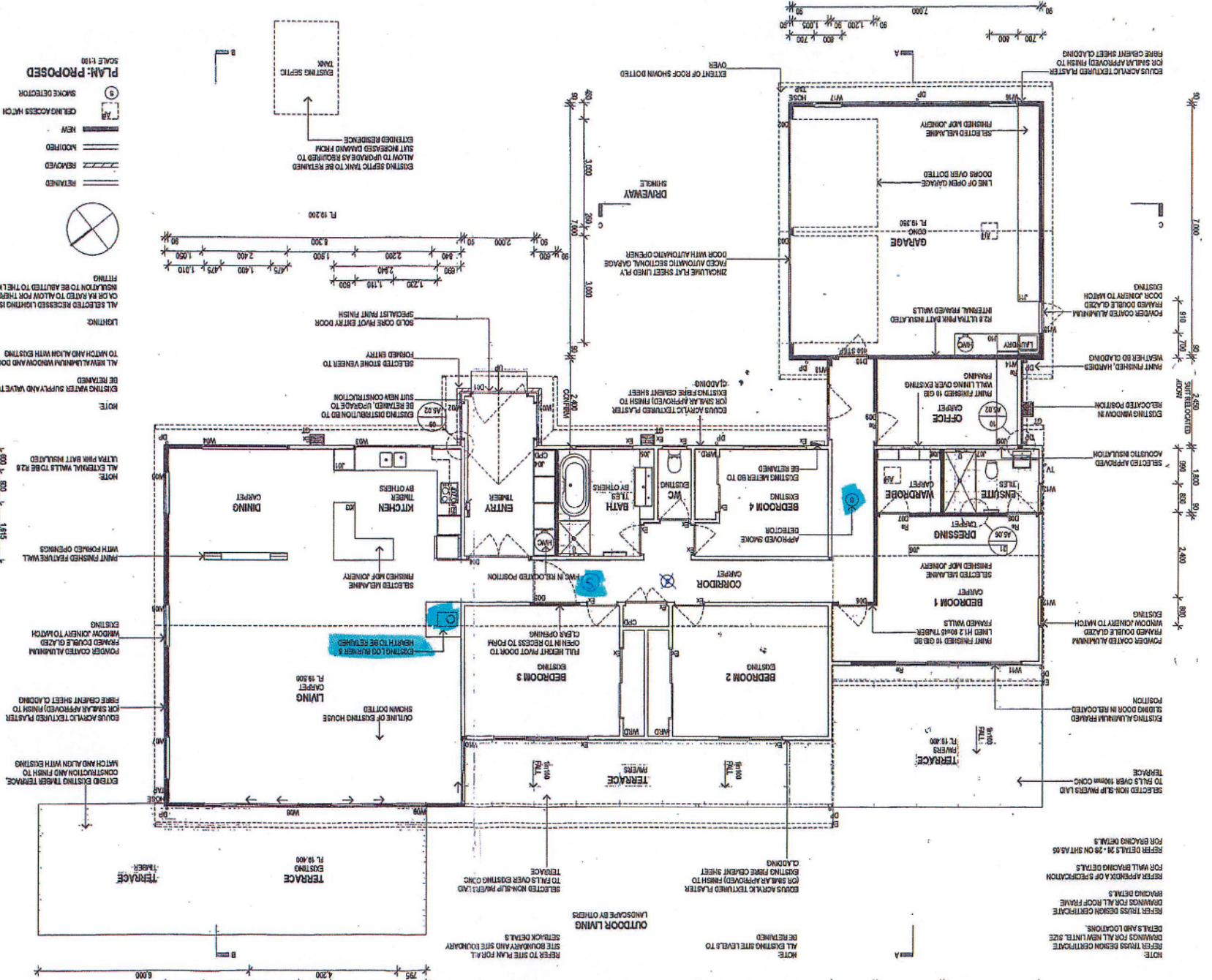

PLANS: PROPOSED

- REMAINS
- REMOVED
- MODIFIED
- NEW

PLAN: PROPOSED
SCALE 1:100

- SMOKE DETECTOR
- CEILING ACCESS HATCH

PLANS: PROPOSED

sheet: _____
scale: 1:100 @ A3
date: 05 February 2010
proj no.: 08113

PLANS: PROPOSED

sheet: _____
scale: 1:100 @ A3
date: 05 February 2010
proj no.: 08113

PLANS: PROPOSED

sheet: _____
scale: 1:100 @ A3
date: 05 February 2010
proj no.: 08113

PLANS: PROPOSED

sheet: _____
scale: 1:100 @ A3
date: 05 February 2010
proj no.: 08113

PLANS: PROPOSED

sheet: _____
scale: 1:100 @ A3
date: 05 February 2010
proj no.: 08113

PLANS: PROPOSED

sheet: _____
scale: 1:100 @ A3
date: 05 February 2010
proj no.: 08113

PLANS: PROPOSED

sheet: _____
scale: 1:100 @ A3
date: 05 February 2010
proj no.: 08113

PLANS: PROPOSED

sheet: _____
scale: 1:100 @ A3
date: 05 February 2010
proj no.: 08113

PLANS: PROPOSED

sheet: _____
scale: 1:100 @ A3
date: 05 February 2010
proj no.: 08113

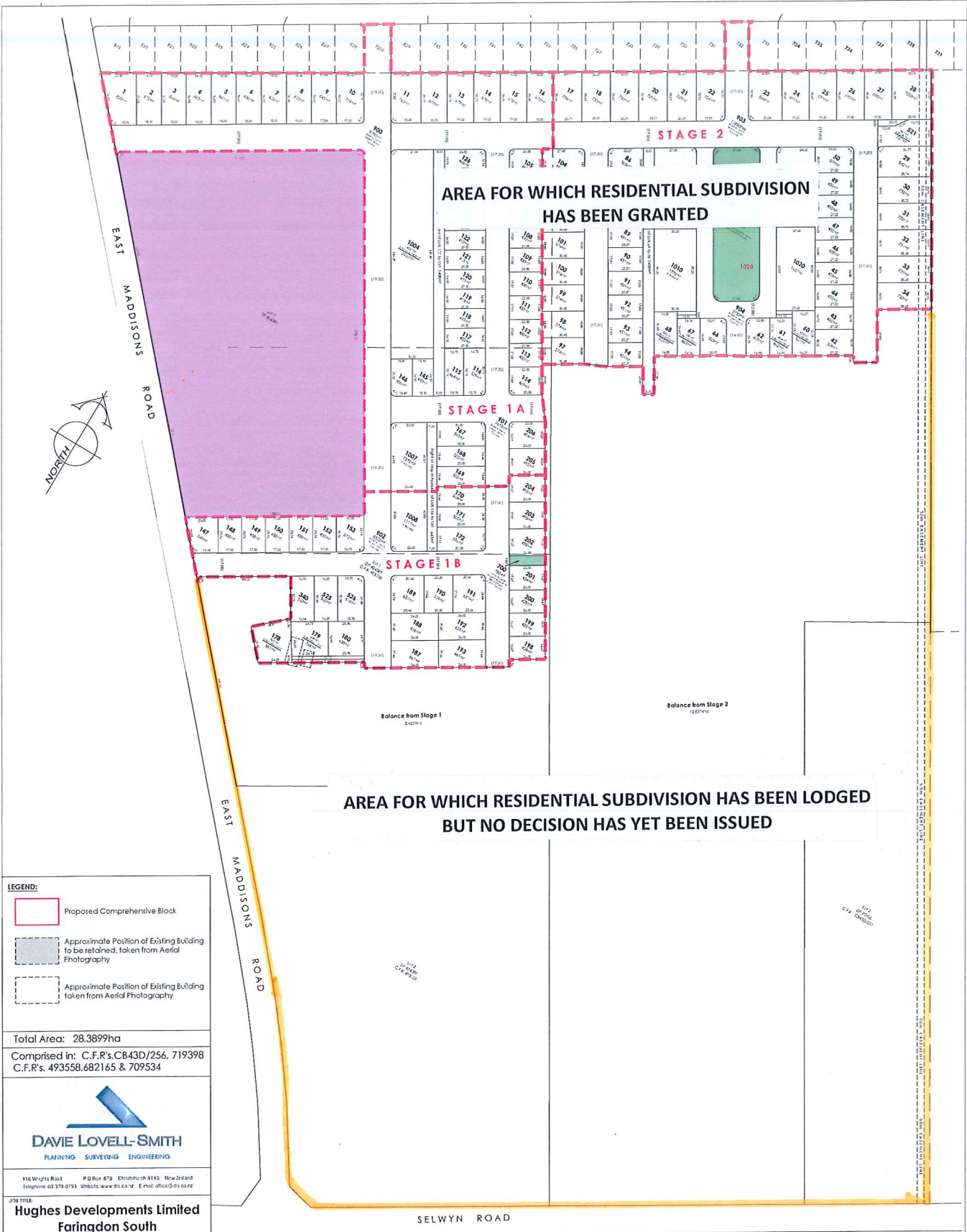

LEGEND:

- Proposed Comprehensive Block
- Approximate Position of Existing Building to be retained, taken from Aerial Photography
- Approximate Position of Existing Building taken from Aerial Photography

Total Area: 28.3899ha
 Comprised in: C.F.R.'s.CB43D/256, 719398
 C.F.R.'s. 493558,682165 & 709534



116 Wright Road PO Box 879 Christchurch 8143 New Zealand
 Telephone: 03 379 8753 Website: www.dls.co.nz E-mail: office@dls.co.nz

JOB TITLE
 Hughes Developments Limited
 Faringdon South
 Rolleston

SHEET TITLE
 Proposed Subdivision
 of Lot 1 DP 75986, Lot 1 DP 424089,
 Lot 2 DP 493381, Lot 732 DP 483427
 & Lot 7004 DP 490736 Stages 1 & 2

DRAWING STATUS
 For Subdivision Consent

SCALE: 1:1250@A1 DATE: September 2016
 1:2500@A3

CLIENT: H18894.Density
PROJECT: SHEET NO: R14

- NOTES:**
- 1) Areas and dimensions are approximates & subject to final survey and deposit of plans.
 - 2) Service easements to be created as required.
 - 3) This plan has been prepared for subdivision concept purposes only. No liability is accepted if the plan is used for any other purpose.
 - 4) Any measurements taken from information which is not dimensioned on the electronic copy are at the risk of the recipient.
 - 5) This plan is subject to the granting of subdivision and/or resource consents and should be treated as a proposal until such time as the necessary consents have been granted by the relevant authorities.
 - 6) This plan has been prepared for the use of Hughes Developments Limited only and no liability is accepted in relation to any other parties.
 - 7) Please note this plan is rotated.

REVISION	DATE	DESCRIPTION
R7	02.6.16	LOTS 1004,1009,1010,1019,1020,33-42 & 60-68 AMENDED & LOTS 145-146 ADDED
R8	09.6.16	LOTS 178-183,343,325,326,1000,1009,1010,1019,1020 AMENDED & STAGE BOUNDARIES AMENDED
R9	20.6.16	LOTS 133 & 134 AMENDED
R10	1.7.16	LOTS 51-54,154-163, 900 & 902 AMENDED
R11	21.7.16	LOTS 904&1000 AMENDED
R12	28.7.16	LOTS 51-59,79 & 80 AMENDED
R13	29.09.16	COMPREHENSIVE LOTS & STAGE BOUNDARY AMENDED
R14	13.09.16	COMPREHENSIVE LOTS AMENDED



INTERACTION BETWEEN EXISTING ACTIVITIES IN RURAL ZONES

When considering buying a rural property, especially if it is a small block, there are some important things that need to be considered.

Zoned rural these areas are foremost for Horticultural and Agricultural farming, plus their associated activities. As these activities operate 24 hours a day seven days a week, it is important to appreciate that as towns and cities have their own unique characteristics, so too do rural areas.

In particular your attention is drawn to the following matters that are part of the rural character of the District.

- (a) Use of agricultural chemicals including ground or aerial application of sprays and fertilisers, subject to manufacturers instructions, adopted codes of practice and other formal controls.
- (b) Some farming activities may commence early in the morning or operate through the night such as harvesting of crops, operation of irrigators or bringing dairy cows in for milking.
- (c) Although excessive noise is not permitted the noise levels associated with permitted land uses such as orchard sprayers, birdscarers, cowsheds (especially at dawn), woolsheds, use of working dogs, aircraft for rural management, tractors, headers and assorted agricultural machinery will in the majority of situations not be considered excessive. Farm animals may make a substantial amount of noise especially deer during the roar, bulls, animals at weaning time, roosters, donkeys and peacocks.
- (d) There are a variety of rural odours including those from established piggeries, spraying of animal effluent on pasture, silage, growing of certain crop species, burning of orchard prunings, hedge prunings and stubble, application of fertilisers, spray from farm chemicals and composting.
- (e) District roads are used to move stock from on part of a farm to another, or one property to another. It is therefore in the landowners best interests to maintain stock proof road boundary fences and gates.
- (f) The existing state of district roads serving the property must be recognised, particularly if any road is unsealed. Unsealed roads can create dust. Dust can also be generated from paddocks when they are being worked or during strong winds.
- (g) Fencelines along road frontages do not always follow the legal road boundary. The road boundary can frequently be located inside what looks like private property.
- (h) Rural dwellings depend upon septic tanks and on-site systems for the disposal of sewage. The septic tanks are the responsibility of the property owner and require regular maintenance to ensure proper functioning.
- (i) Council water supply is not available to every property. Where it is not available, and the landowner seeks to construct a new dwelling, the District Council will not issue a Code Compliance Certificate until the owner provides proof that a potable water supply is available.

Be water wise



Reducing water use is important as Selwyn households tend to be high users of water. Residential properties connected to a Council supply used an average of 1,470 litres of water per day in 2012/13 and 1,386 litres per day in 2011/12. As a comparison, typical household use in New Zealand is around 675 litres per day.

Part of the reason why Selwyn households have higher water consumption is because properties tend to have large sections and over dry summers water use can increase

significantly. Additional bores can be added to increase the capacity of Council water supplies, but this is costly and unsustainable.

Over summer, demand for water is much higher than in winter, as people use more water to maintain their lawns. When demand for water is very high during dry summers, water restrictions can be introduced if necessary.

Demand is especially high at the peak times of 6–9am in the morning and 4–9pm in the evening, when people

use water for cooking, washing and dishwashers, and often water their lawns at the same time.

We are asking everyone to be careful about how they use water, especially in summer when there is more demand for water. Some areas like Rolleston and Darfield also pay for their water based on metered use so reducing your water consumption will mean you spend less on water bills.

How much water do you use?

This chart shows the amount of water typically used for different household activities. Once you know where your water is going, you can think about how you could reduce your water use. If your water is metered and billed this will help reduce how much you spend on water.

Kitchen—Activity	Water used	Buckets
Dishwashing by Hand	12 to 15 litres per wash	1–1½
Dishwasher	20 to 60 litres per wash	2–6
Drinking, Cooking, Cleaning	8 litres per person	¾–1
Bathroom—Activity	Water used	Buckets
Toilet	4.5 to 11 litres per flush	½–1
Bath	50 to 120 litres (half full)	5–12
Shower (8 minutes)	70 to 160 litres per 8 minutes	7–16
Handbasin	5 litres	½
Tap Running (Cleaning teeth, washing hands)	5 litres	½
Leaking Tap	200 litres	20
Laundry—Activity	Water used	Buckets
Washing Machine (Front loading)	23 litres per kg of dry clothing	4–5
Washing Machine (Top Loading)	31 litres per kg of dry clothing	5–6
Outside—Activity	Water used	Buckets
Hand Watering by Hose	600 to 900 litres per hour	60–90
Garden Sprinkler	Up to 1500 litres per hour	150
Car Wash with Hose	100 to 300 litres	10–30
Filling Swimming Pool	20,000 to 50,000 litres	2,000–5,000
Leaking Pipe (1.5mm hole)	300 litres per day	30



Tips for managing your water use

You can help manage your water consumption wisely by following these tips:

Your garden and lawn

- Water your garden and lawn every few days rather than every day. Wetting the soil surface every day encourages roots to develop at the surface, making them more vulnerable to hot dry spells.
- Water your garden and lawn outside of peak water usage hours (avoid 6am–9am, and 4pm–9pm). Watering in the early morning (before 6am) or late evening (after 9pm) will minimise evaporation loss. Also avoid watering in a Nor' West wind as the water will quickly evaporate.
- Using a watering can or hand watering plants by hose often uses far less water than a sprinkler.
- Use a timer to avoid overwatering as it makes plants more susceptible to fungus diseases and will leach out soil nutrients.
- Use mulch or cover the soil with a layer of organic matter to keep the soil moist. Mulches help protect plant roots from drying effects of sun and wind and also reduce weed growth.

- Check if the soil needs watering by digging down with a trowel and having a look. This is a more accurate way to see if watering is needed than looking at the surface.
- Check you have the right head for your sprinkler. Sprinklers should apply water gently so that it seeps into the soil. Some sprinklers apply water faster than the soil can absorb.
- When planting choose drought resistant plants that don't require a lot of water.



Outdoors

- Wash your car with a bucket of water rather than a hose.
- Use a broom rather than hosing down paths and driveways.
- Inspect hoses and taps both indoors and outdoors to check for leaks which waste water.
- Collect rainwater for use watering gardens and lawns.
- If you have a swimming pool, keep it covered to stop the water evaporating.

Indoors

- Reduce your water consumption at the peak times of 6-9am and 4-9pm. Easy ways to do this include using your washing machine after 9pm at night, and putting your dishwasher on just before you go to bed.
- Take a short shower instead of a bath.
- Don't switch on the dishwasher or washing machine until you have a full load.
- Use a half flush when using the toilet.

DRAINAGE PICKUP

CONSENT NUMBER

Address: 6/5/2011
 Date: 4/7/ East middians rd

Drainlayer: Pikoy Moore Drainage LTD
 Done Willis - 24133
 Inspector:

100282

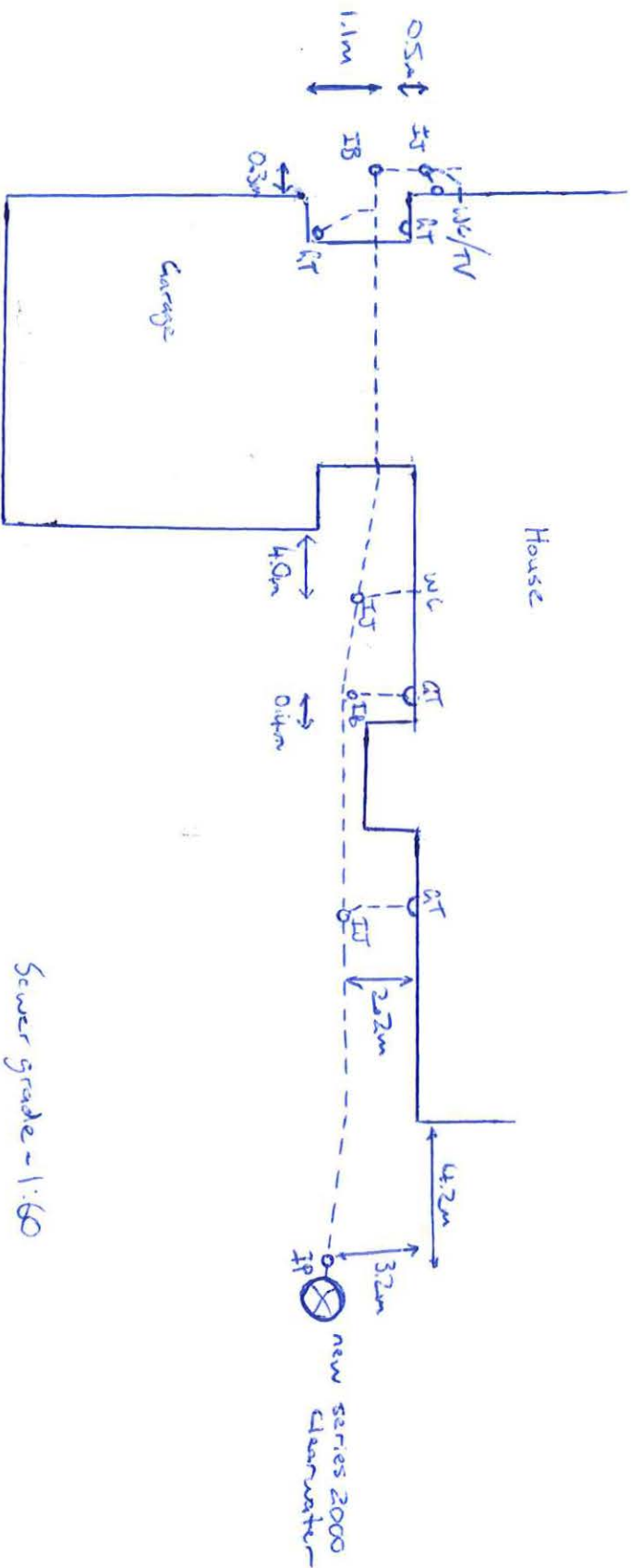

Breit Miller
Reg # 19732

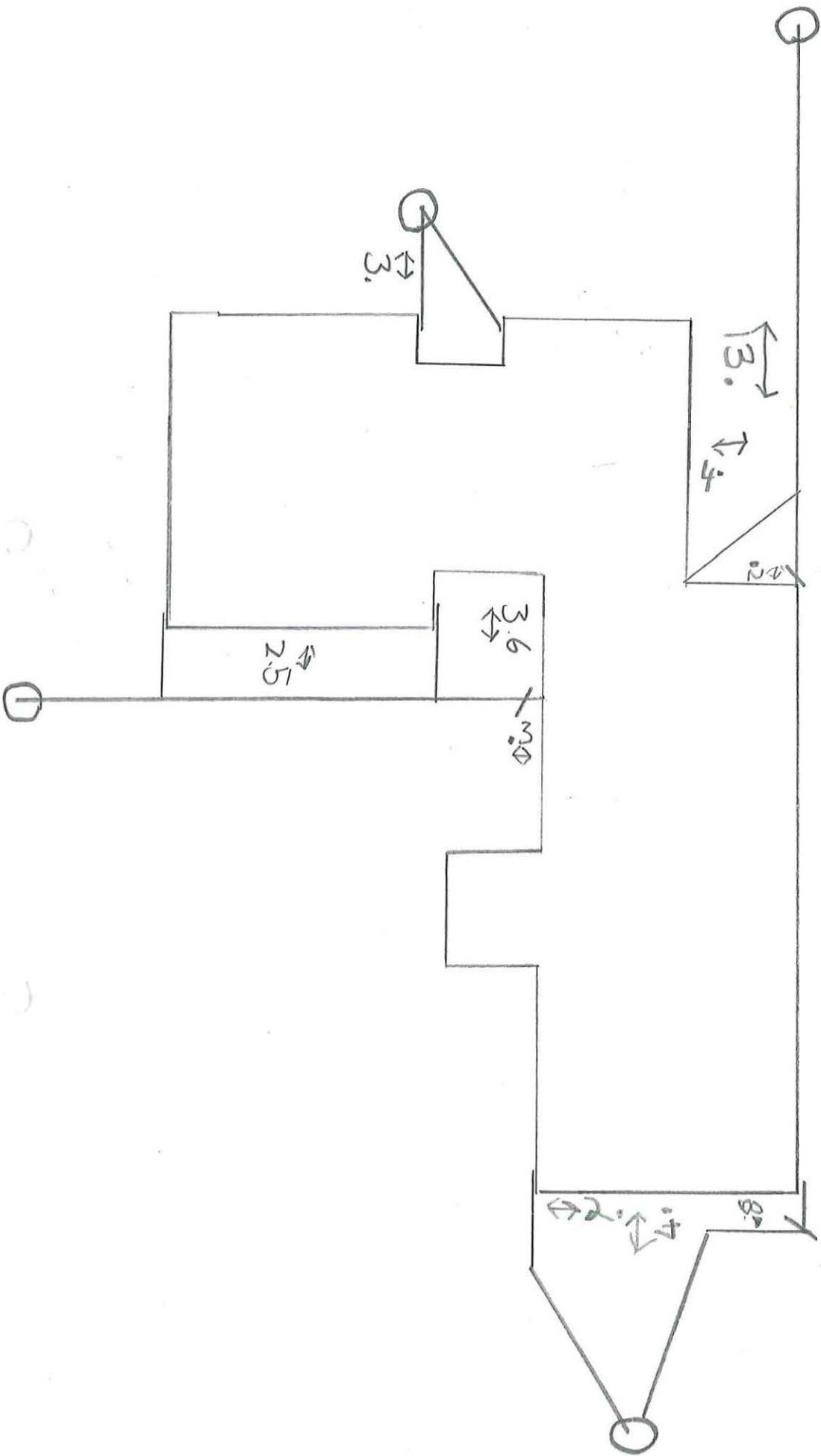

Leeston

owner Duffy
CNR Maddisons / Selwyn Rd
9/1/90
D/C B+S Plumbing
(Steve Shepherd)
PL John Raynor

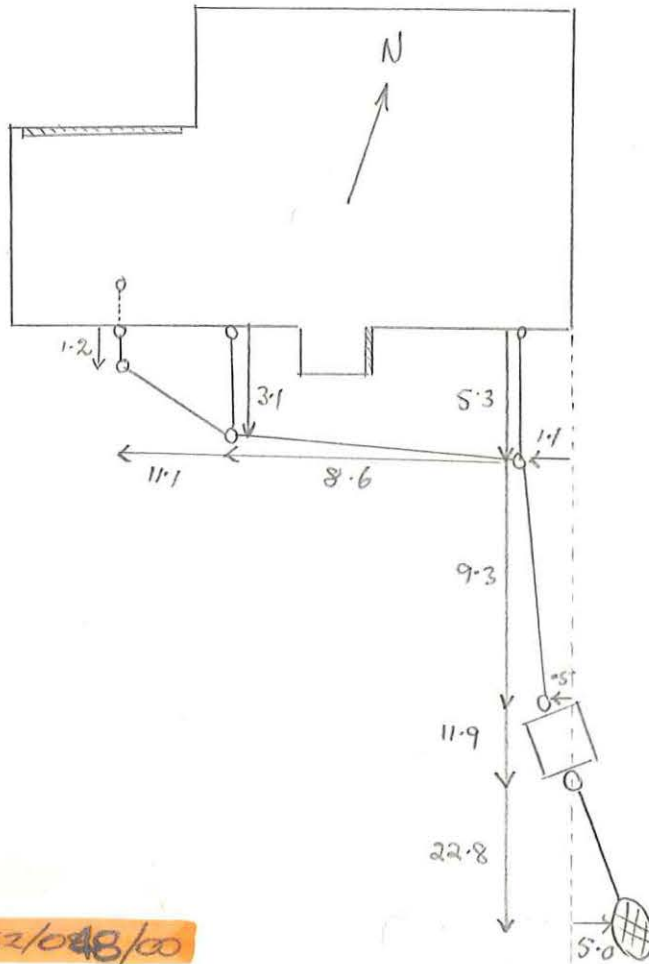

24052/048/00



2 Norman Kirk Drive, Rolleston, New Zealand
 PO Box 90, Rolleston 7643
 Telephone (03) 347-2800
 Toll-free Darfield (03) 318-8338
 Enquiries: accounts.receivable@selwyn.govt.nz

Parry Fields Lawyers
 PO Box 8020
 Riccarton
 Christchurch 8440

GST Number: 53-113-451
Invoice Date: 22/03/21
Account No: 803328
Order No.

Tax Invoice 155968

Quantity	Description	Rate	Amount
	L210616 19/03/21 : 102633-287 : Parry Fields Lawyers : Chri 2405533900 : 479 East Maddisons Road		
	Land Information Memorandum Fee		204.40 *
			\$204.40
	(* Incl GST \$26.66)		

Total incl. GST \$204.40

(Please detach and return this portion with your payment)

REMITTANCE ADVICE

Parry Fields Lawyers
 PO Box 8020
 Riccarton
 Christchurch 8440

Account No.: 803328
Invoice No.: 155968
Total Due: \$204.40

Amount Enclosed:

Payment can be made by internet banking to the following account: 03 1587 0050000 00.

Please enter your account number in the particulars field, and your invoice number in the code field.

